

Correct the given poorly dimensioned drawings.

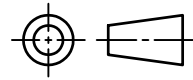

(a)

GIVEN

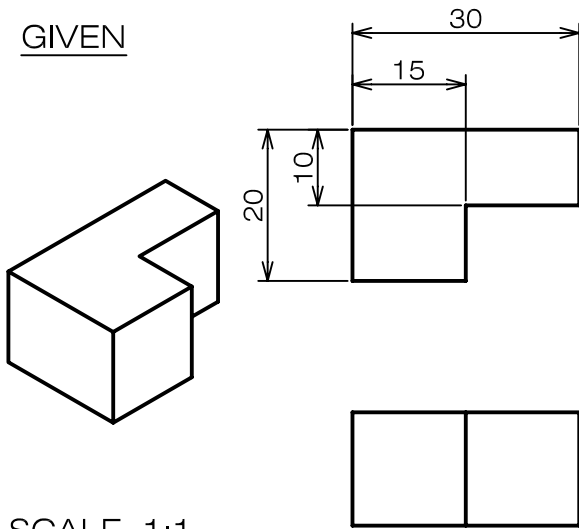

SCALE 1:1

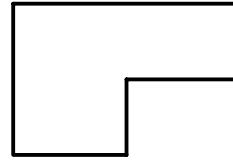

SCALE 1:1

(b)

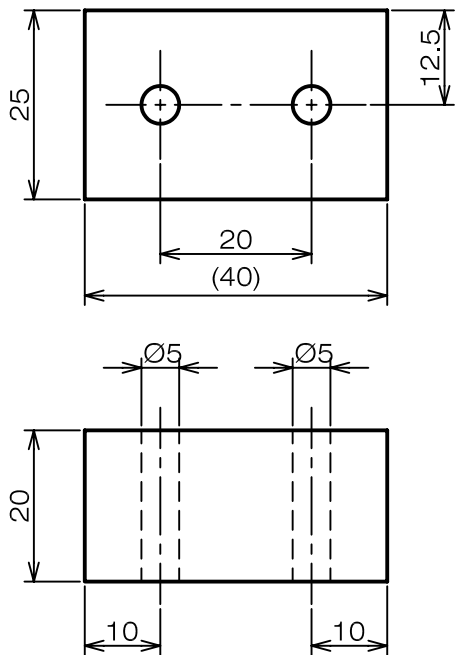
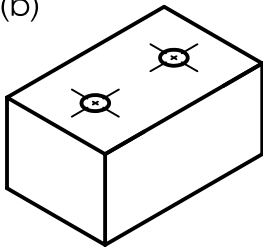

SCALE 1:1

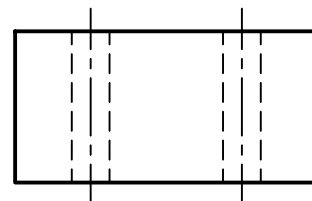
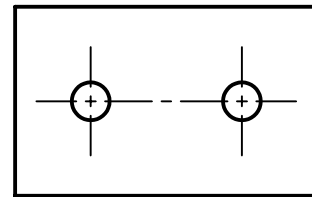
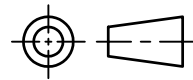

SCALE 1:1