

Complete the given orthographic drawings with a missing dash line(s).

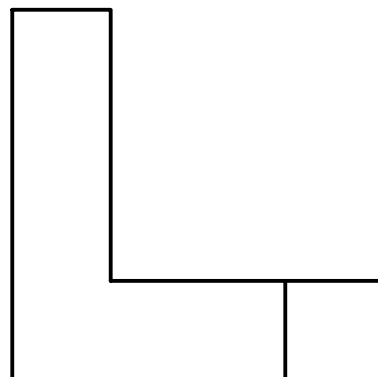

Complete the given orthographic drawings with a missing dash line(s).

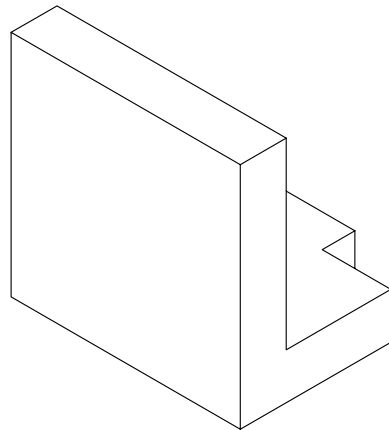
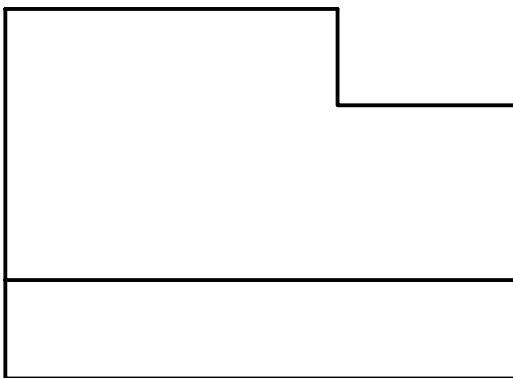
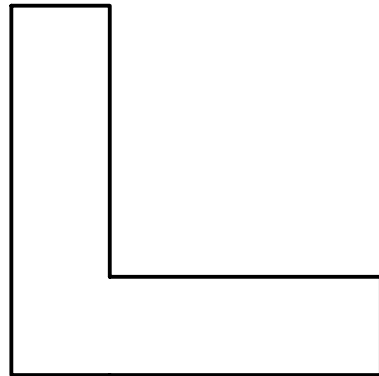
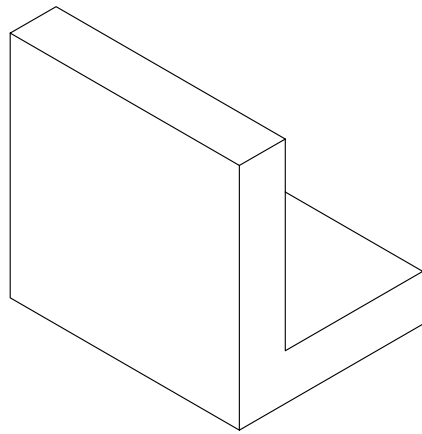
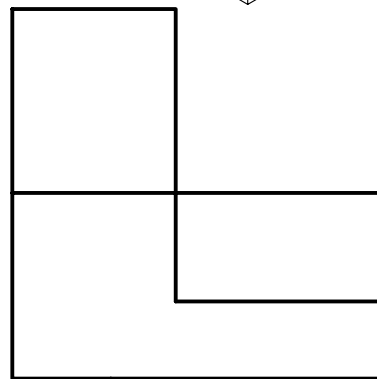
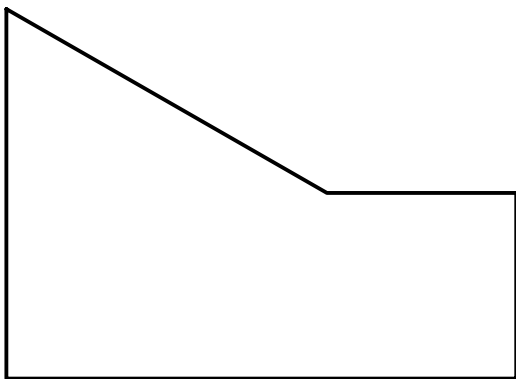
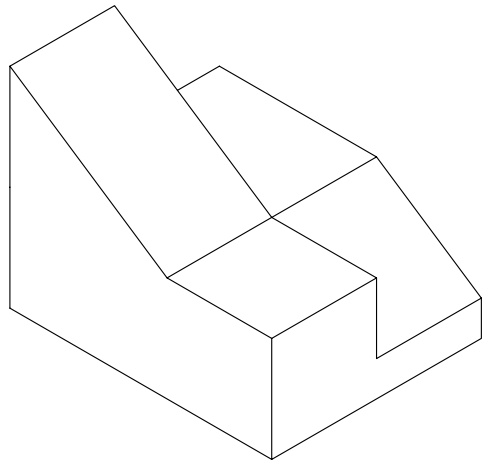
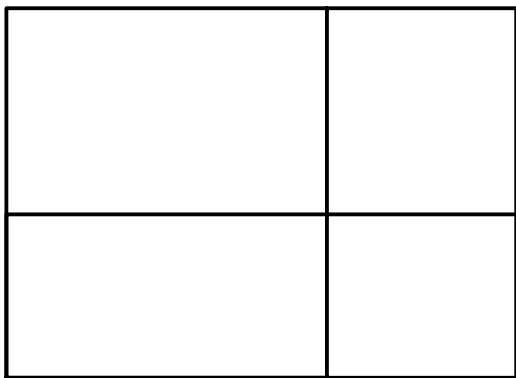
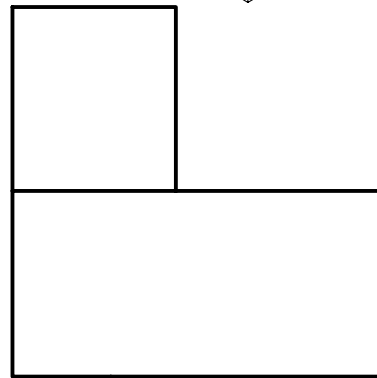
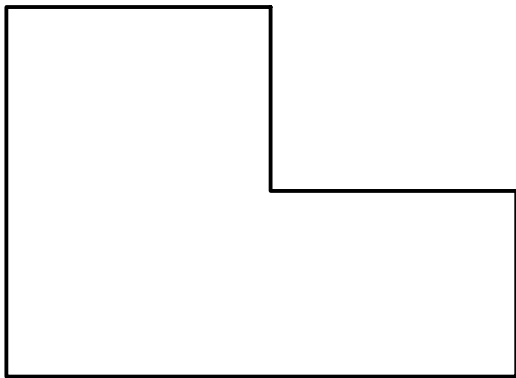
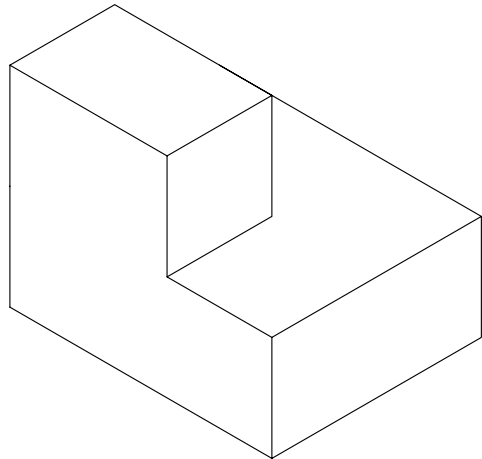
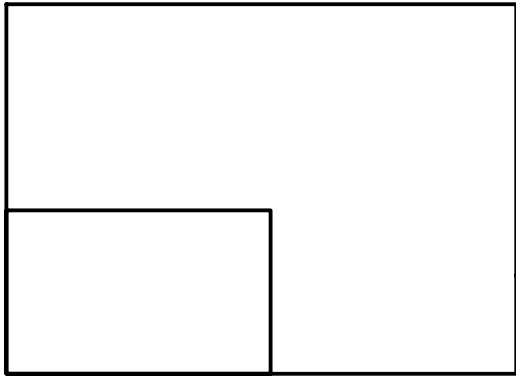

Complete the given orthographic drawings with a missing dash line(s).and center lines.

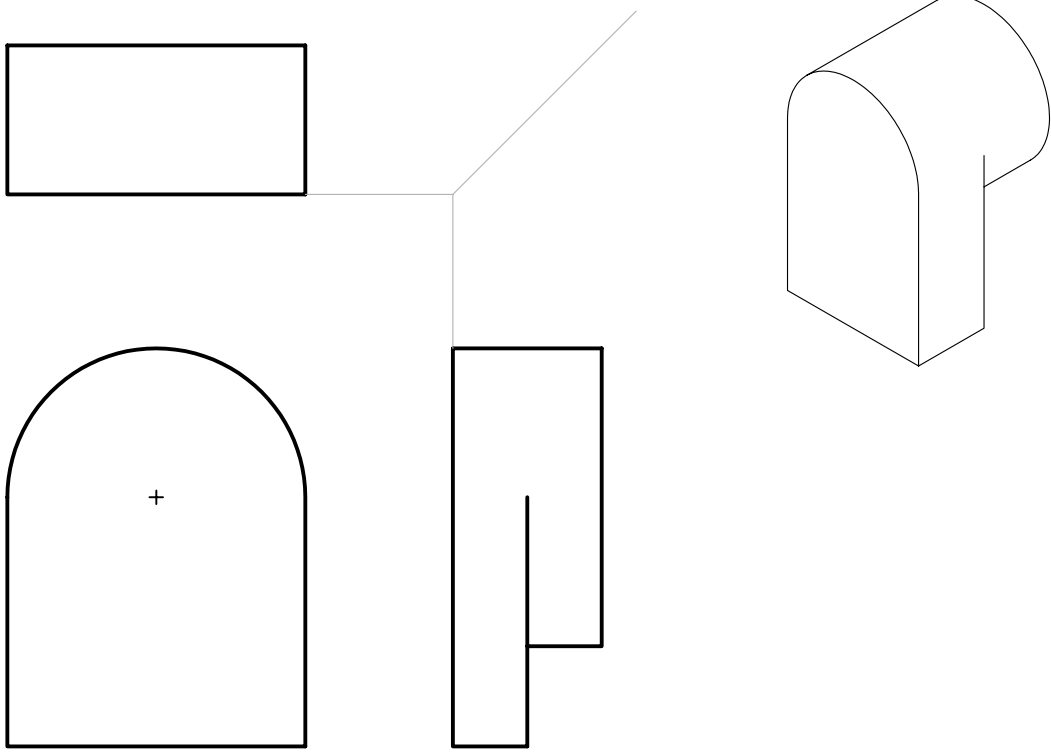

NOTE : Freely specify the end position of the slot.

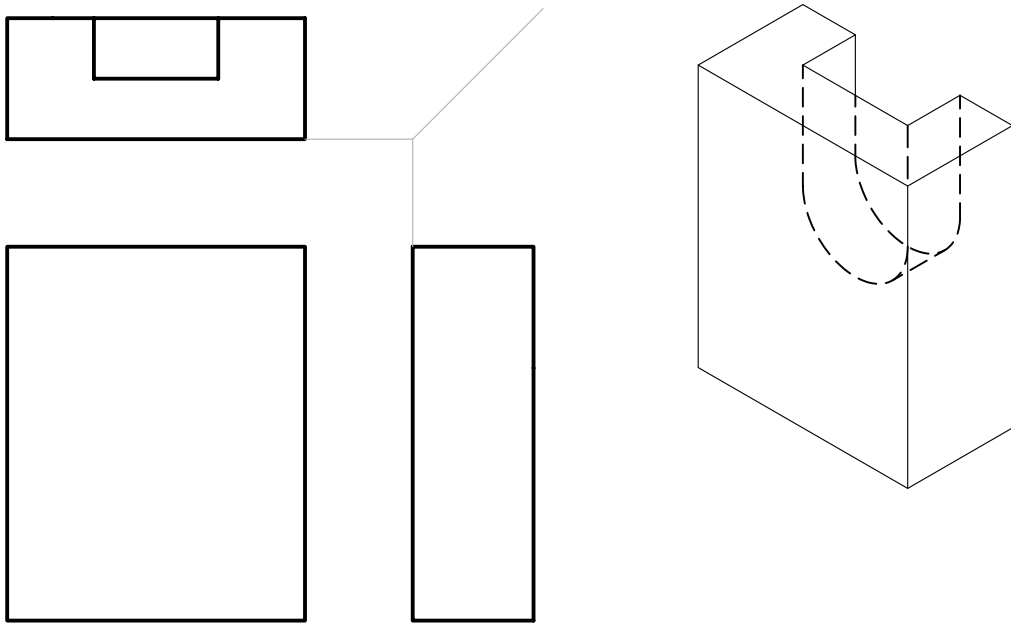

Complete the given orthographic drawings with a missing dash line(s).

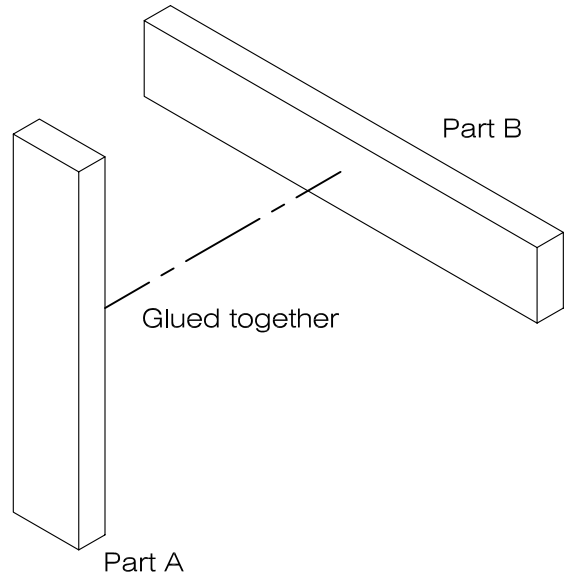
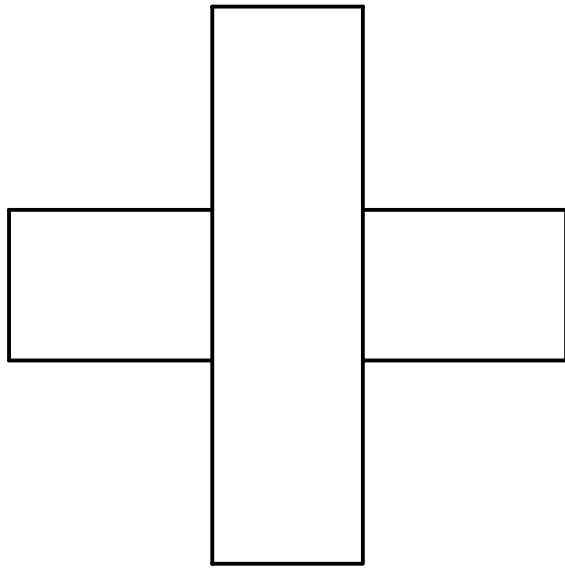

Complete the given orthographic drawings with a missing dash line(s) and center lines.

NOTE : Freely specify the end position of the slot.

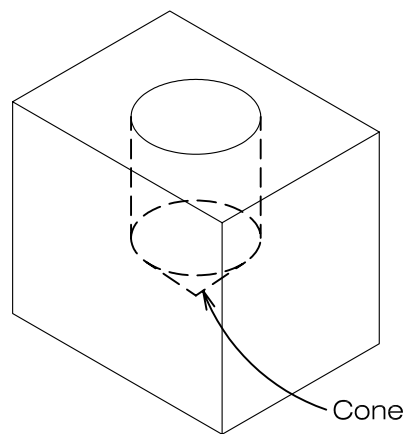
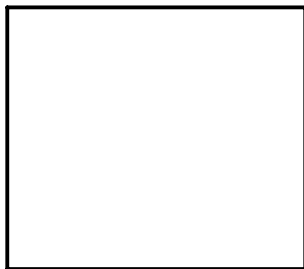
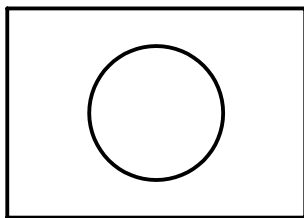

Complete the center lines to the given view.

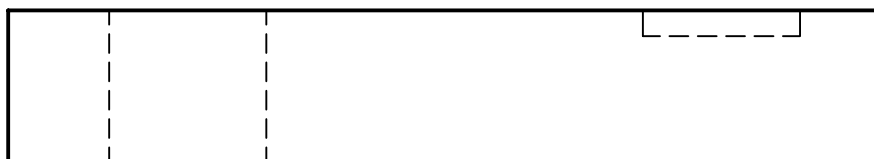
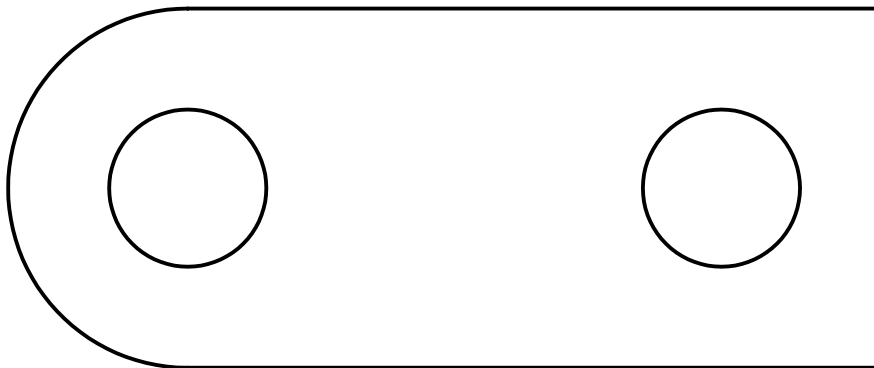
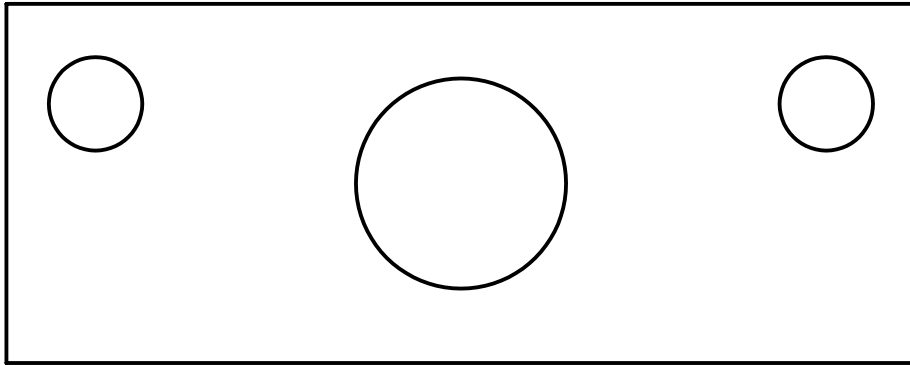

Complete the center lines to the given view.

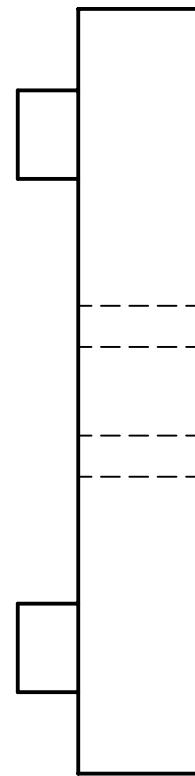
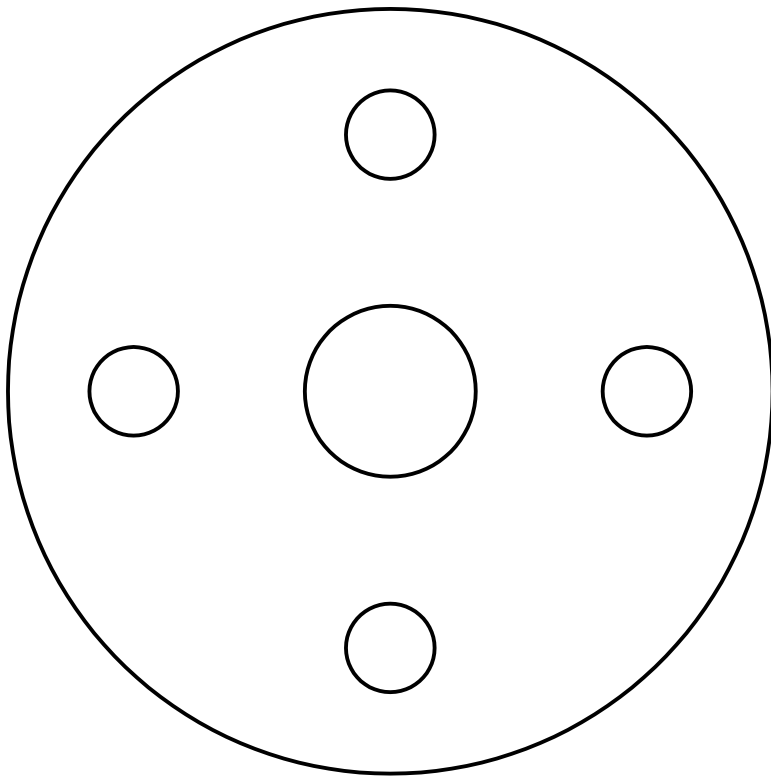
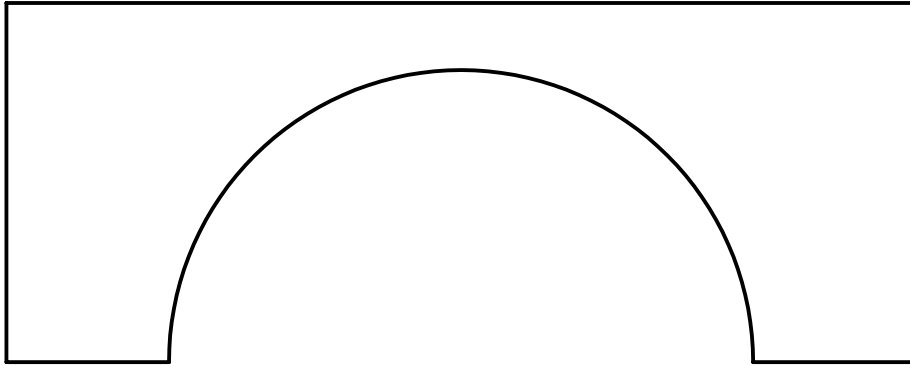

Complete the center lines to the given view.

