

2141-375

Measurement and Instrumentation

**Basic Concepts of
Measurement Methods**

What Is Measurements?

Measurement:

an estimation of a physical (chemical or biological) variable by a measurement device.

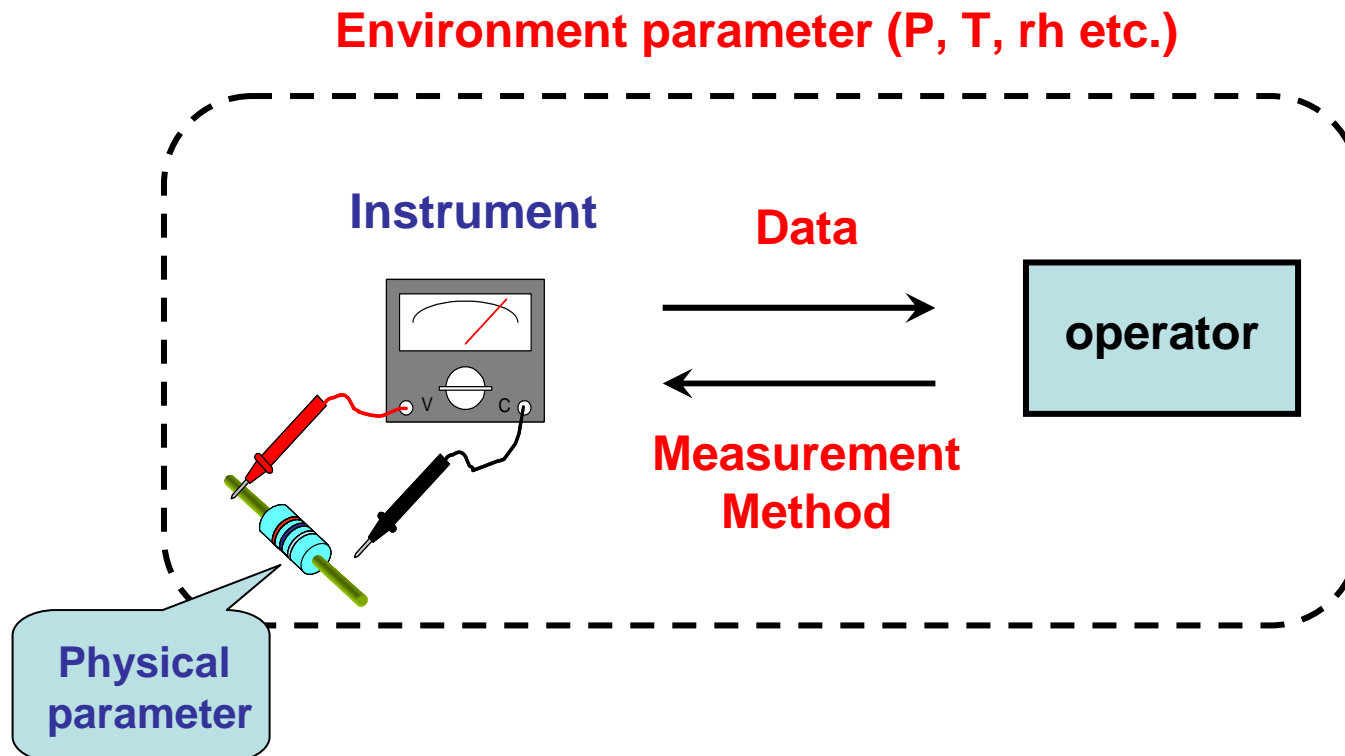

General Measurement System

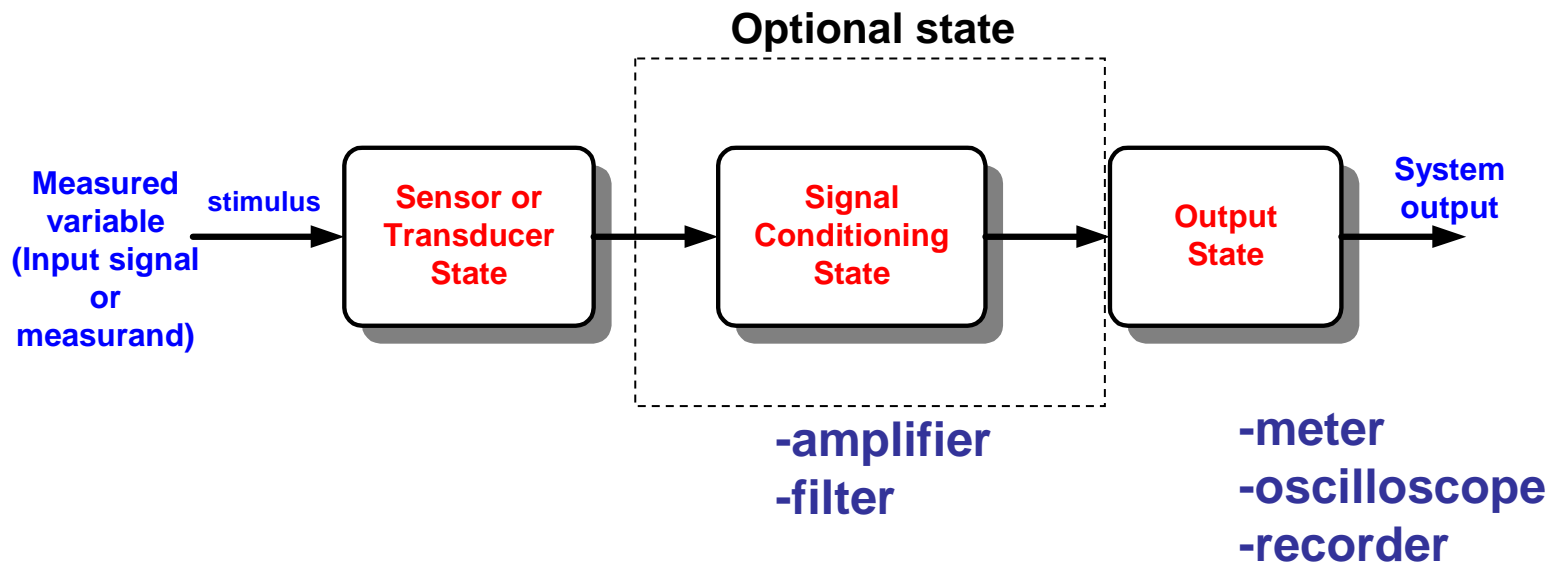

Sensor or transducer is an input device **convert the quantity under measurement into a detectable signal form: electrical, mechanical, optical etc.**

Signal conditioning **modifies the transducer signal into a desired form e.g. amplification, noise reduction.**

Output State **provides an indication of the value of the measurement (readout device or recording)**

Examples of Measurement Systems

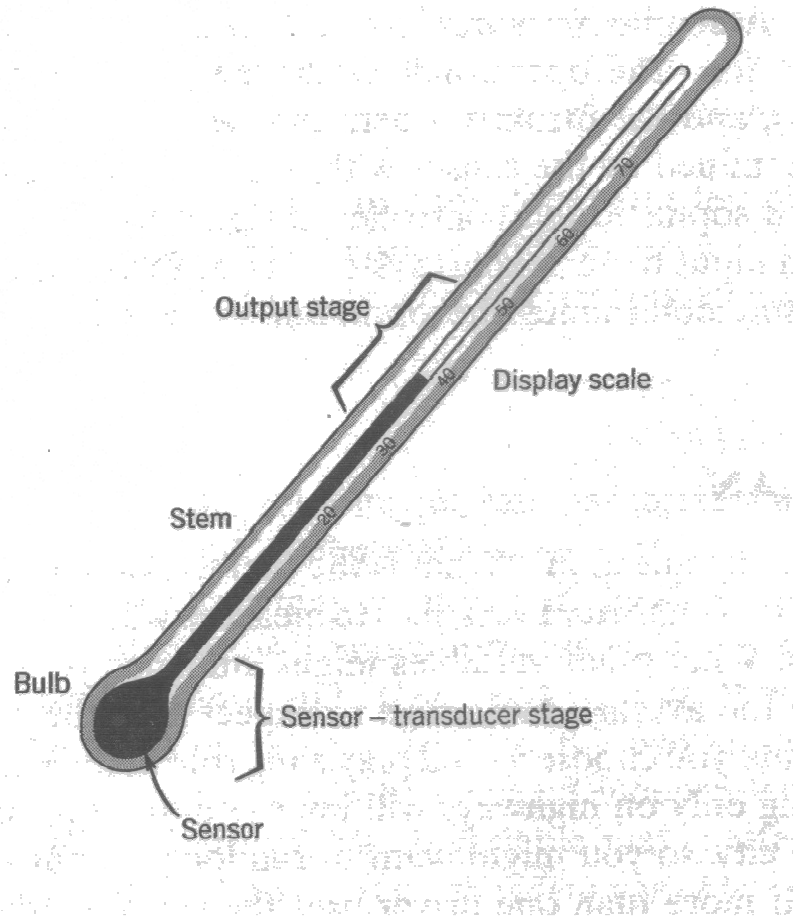

A bulb thermometer

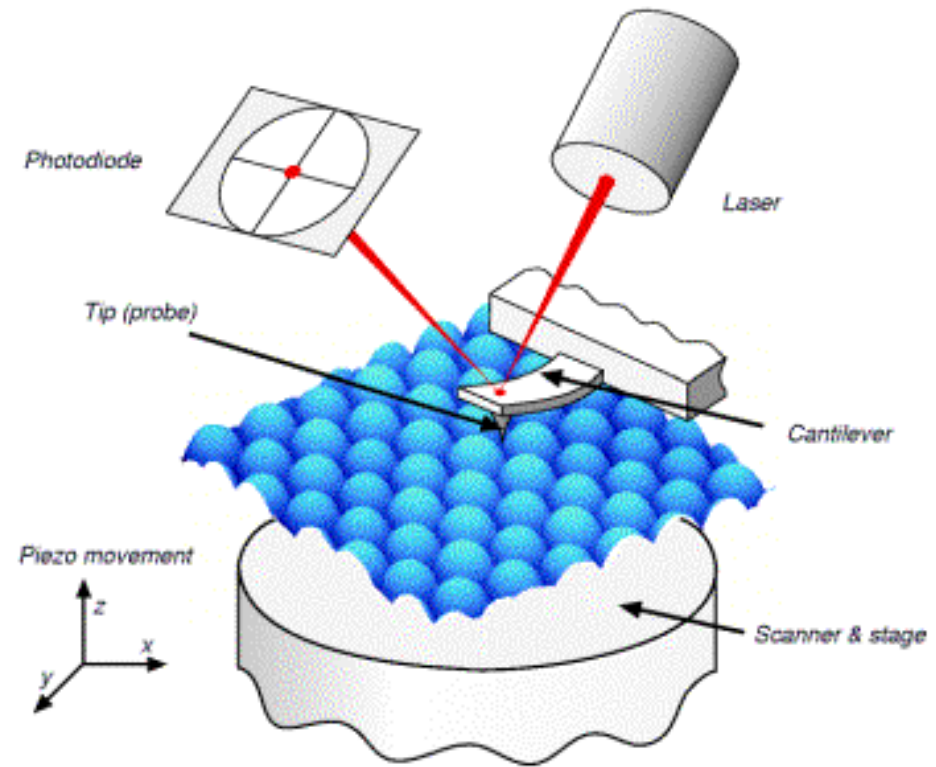

Atom Force Microscope: example of a complicated system

Some Useful Definitions

Transducer

- a device which converts a signal from one physical form to a corresponding signal having a different physical form. (energy converter)

Sensor (input transducer)

- a device converts **the physical or non-physical signal** which is to be measured into **an electrical signal** which can be processed or transmitted electronically. (physical signal/electrical signal)

Actuator (output transducer)

- a device converts the modified **electrical signal** into **a non-electrical signal**. (electrical signal/physical signal)

Signal domains with examples

Mechanical	Length, area, volume, all time derivatives such as linear/angular velocity/acceleration, mass flow, force , torque, pressure, acoustic wavelength and intensity
Thermal	Temperature, (specific) heat, entropy, heat flow, state of matter
Electrical	Voltage, current,charge, resistance, inductance, capacitance, dielectric constant, polarization, electric field, frequency, dipole moment
Magnetic	Field intensity, flux density, magnetic moment, permeability
Radiant	Intensity, phase, wavelength, polarization, reflectance, transmittance, refractive index
Chemical	Composition, concentration, reaction rate, pH, oxidation/reduction potential

Applications of Measurement System

- ⊕ Monitoring of processes and operations
- ⊕ Control of processes and operations
- ⊕ Experimental engineering analysis

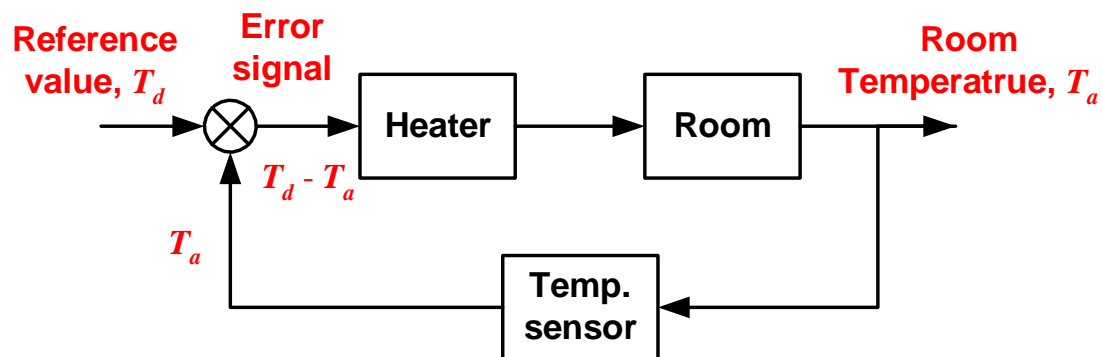

A simple closed-loop control system



Dummy driver

Classification: Active and Passive

Passive or Self-generating Instrument:

an instrument whose output energy is supplied entirely or almost entirely by its input signal

Active or Modulating Instrument:

an instrument has an auxiliary of power which supplies a major part of the output power while the input signal supplies only an insignificant portion.

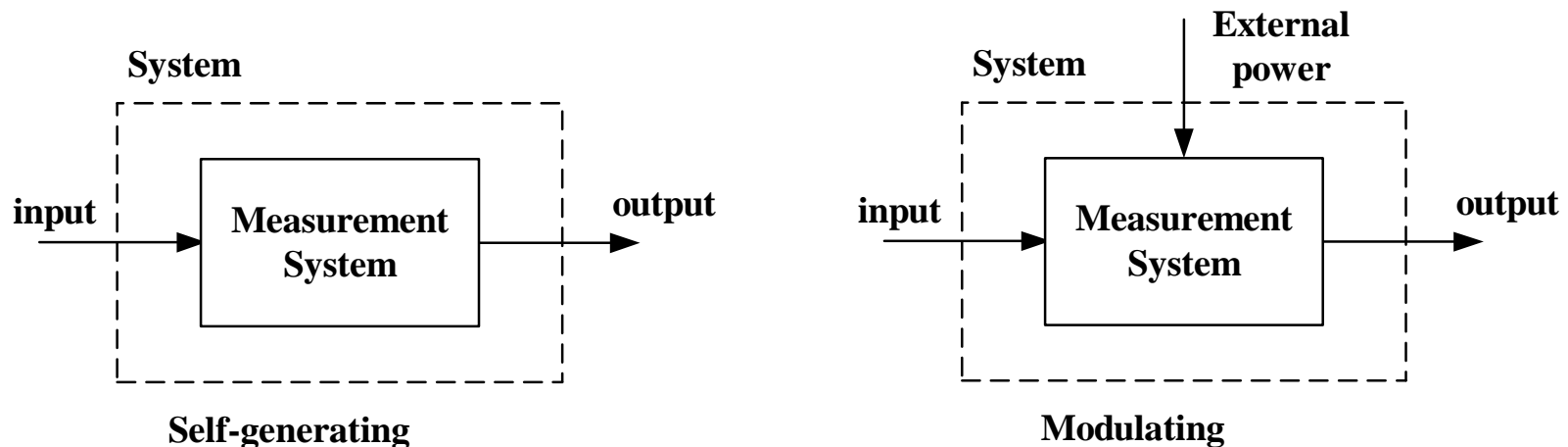

Classification: Null and Deflection Methods

Deflection-type

The measured quantity produces some physical effects that engender a similar but opposing effect in some part of the instrument. The opposing effect increases until a balance is achieved, at which point the “*deflection*” is measured.

Null-type Method:

a null-type device attempts to maintain deflection at zero by suitable application of a known effect opposing the generated by the measured quantity. (a null detector and a means of restoring balancing are necessary).

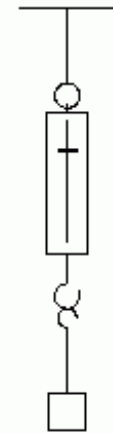

A spring balance

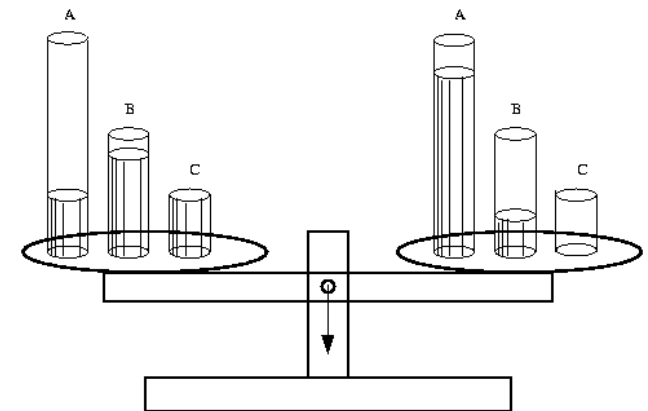

An equal arm balance

Analog and Digital Instruments

Analog Instrument:

An analog instrument gives an output that varies continuously as the quantity being measured changes.

The output can have an infinite number of values within the input range.

Digital Instruments:

The digital instruments has an output that varies in discrete steps and so can only have a finite number of values.



Example of an analog and digital instrument

Classification: Null and Deflection Methods

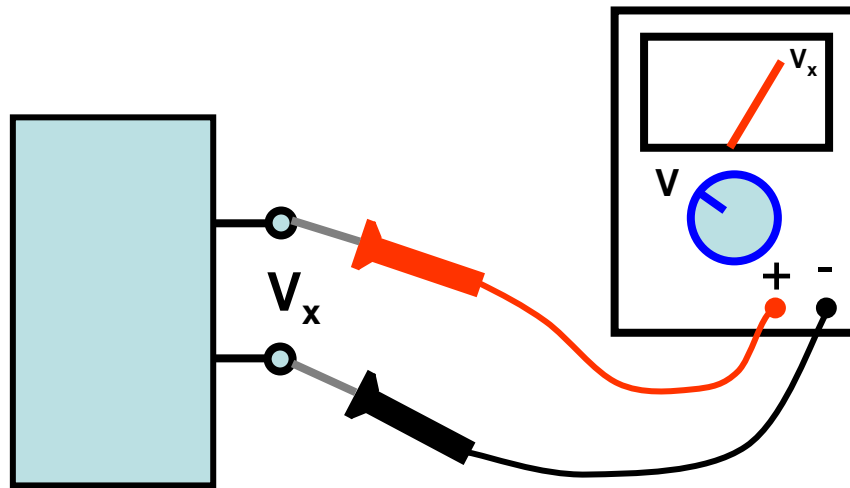

Measuring unknown voltage using a voltmeter

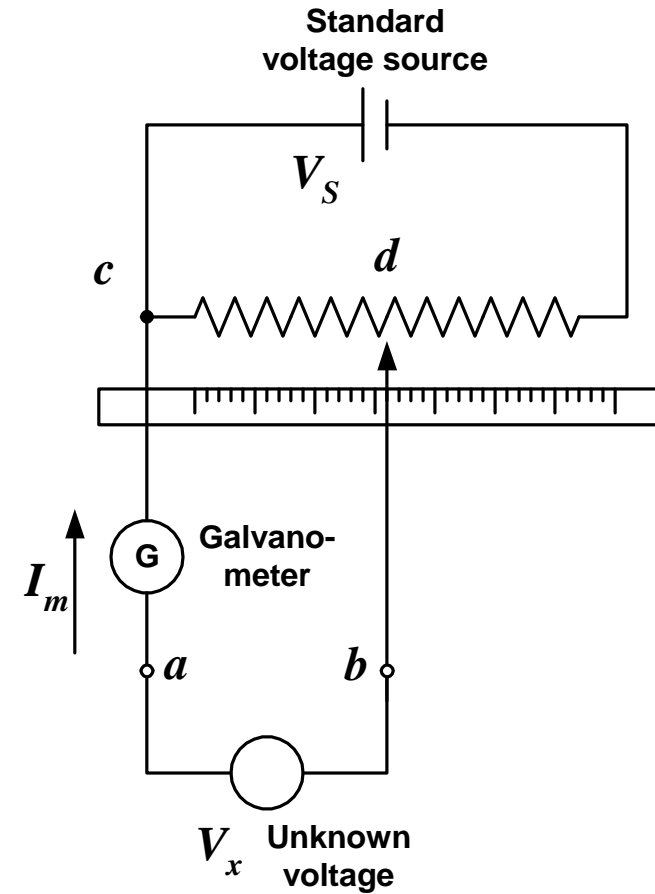

Potentiometer voltage measurement

Experimental Variables

Independent variable

- a variable that can be changed independently of other variables.

Dependent variable

- a variable that is affected by one or more other variables.

Controlled variable

- a variable that can be held at constant value during the measurement process.

Extraneous variable

- a variable that are not or can not be controlled during measurement but can affected the value of the measured variable.

Example of Experimental Variables

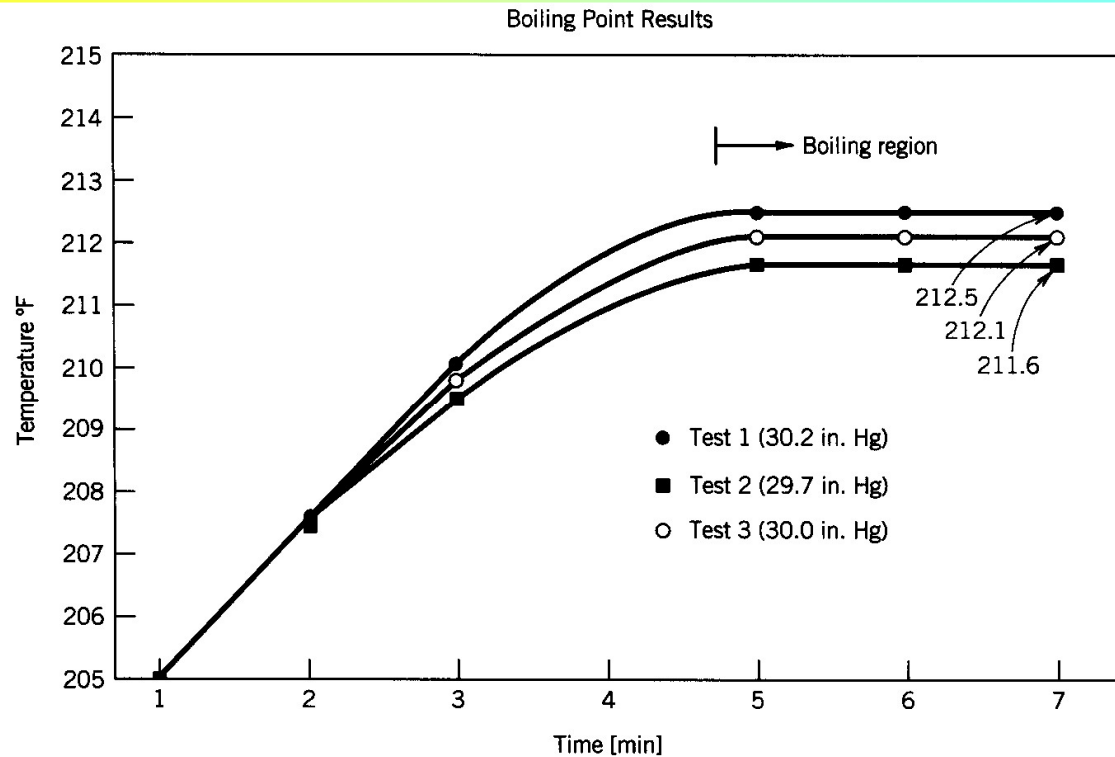

Figure 1.3 Results of a boiling point test for water.

Measured variable: Boiling point (Dependent variable)

Extraneous variable: Atmospheric pressure

Extraneous Variables

Interference

- An undesirable deterministic trends on the measured value because of extraneous variables.

Noise

- a random variation of the value of the measured signal as a consequence of the variation of the extraneous variables.

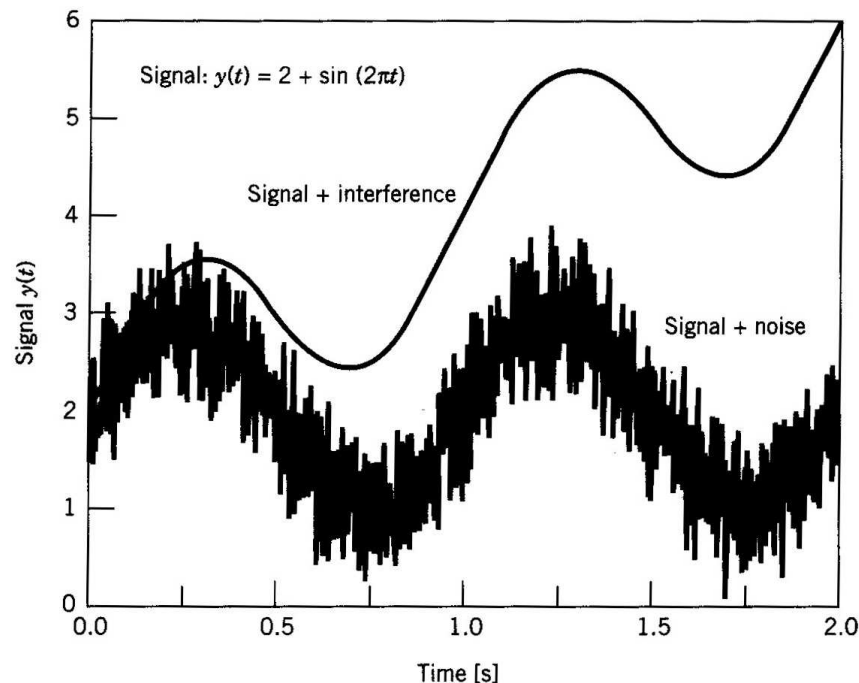

Interference and Noise

Calibration



- Calibration:**

A test in which known values of the input are applied to a measurement system (or sensor) for the purpose of observing the system (or sensor) output.

- Static calibration:**

A calibration procedure in which the values of the variable involved remain constant (do not change with time).

- Dynamic calibration:**

When the variables of interest are time dependent and time-based information is need. The dynamic calibration determines the relationship between an input of known dynamic behavior and the measurement system output.

Static Characteristics

Static Sensitivity: Incremental ratio of the output signal (y) to the desired input signal (x).

$$S = \frac{\Delta y}{\Delta x}$$

$S = \text{constant}$, If y is a linear function of x , i.e. $y = ax + b$

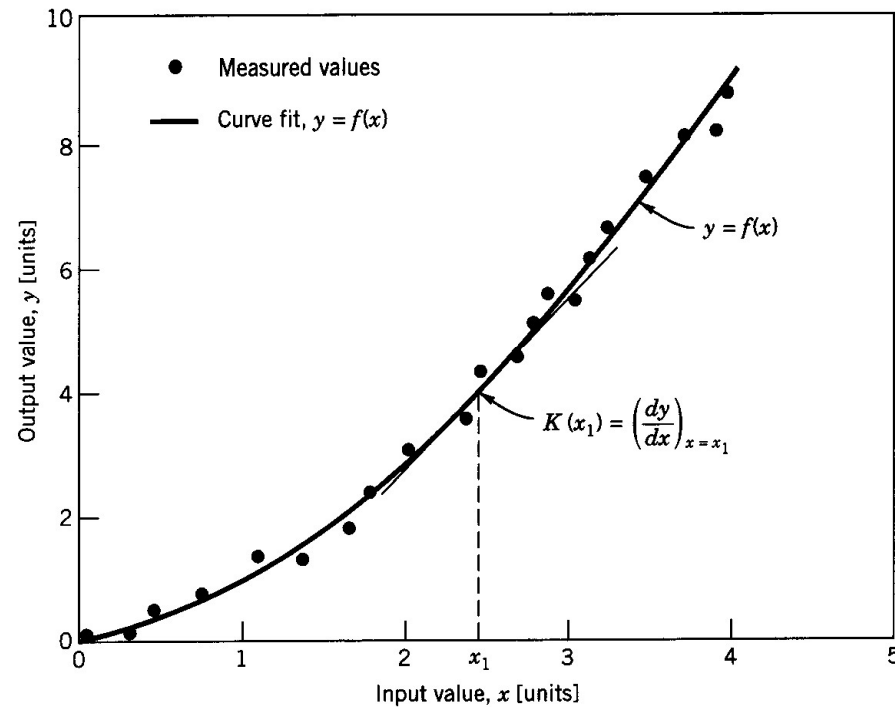

Example of Static calibration curve

Static Characteristics

Measurand range, operating range, full-scale range, span: the range of input variable ($x_{max} - x_{min}$) that produces a meaningful output.

$$r_i = (x_{max} - x_{min})$$

Full scale output (FSO): Difference between the end points of the output. The upper limit of output over the measurand range is called the full scale (FS)

$$r_o = (y_{max} - y_{min})$$

Offset: The output of a sensor, under room temperature condition unless otherwise specified, with zero measurand applied.

Static Characteristics

Accuracy: the difference between the true (expected) and measured values from the measurement system or sensor. Normally, it is quoted in as a fractional of the full scale output.

Percentage of reading

$$\varepsilon_a (\%) = \frac{(y_m - y_t)}{y_t} \times 100$$

Percentage of full scale

$$\varepsilon_f (\%) = \frac{(y_m - y_t)}{y_{FSO}} \times 100$$

Absolute error

ε = indicated value- true value

Static Characteristics

Precision: The ability of the system to indicate a particular value upon repeated but independent applications of a specific value of input. The precision error is a measure of the random variation found during repeated measurements.

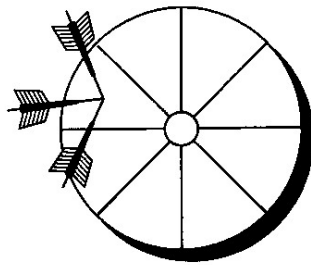

(a) High repeatability gives low precision error but no direct indication of accuracy

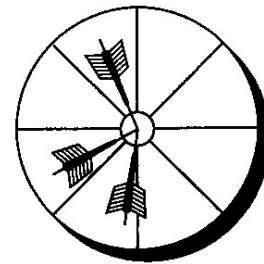

(b) High accuracy means low precision and bias errors

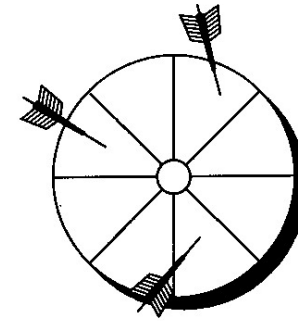

(b) Bias and precision errors lead to poor accuracy

Illustration of precision and bias errors and accuracy

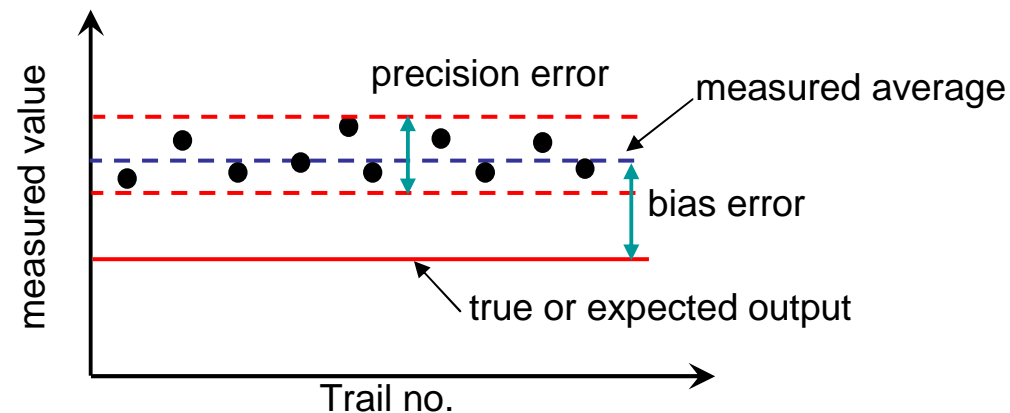

Static Characteristics

Example: Three load cells are tested for repeatability. The same 50-kg weight is placed on each load cell 10 times. The resulting data are given in the following table. Discuss the repeatability and accuracy of each sensor. If the expected output of these load cells is 10 mV.

Trail no.	Load cell output (mV)		
	A	B	C
1	10.02	11.50	10.00
2	10.96	11.53	10.03
3	11.20	11.52	10.02
4	9.39	11.47	9.93
5	10.50	11.42	9.92
6	10.94	11.51	10.01
7	9.02	11.58	10.08
8	9.47	11.50	10.00
9	10.08	11.43	9.97
10	9.32	11.48	9.98
Maximum	11.20	11.58	10.08
Average	10.09	11.49	9.99
Minimum	9.02	11.42	9.92

Static Characteristics

Load cell A

• not repeatable

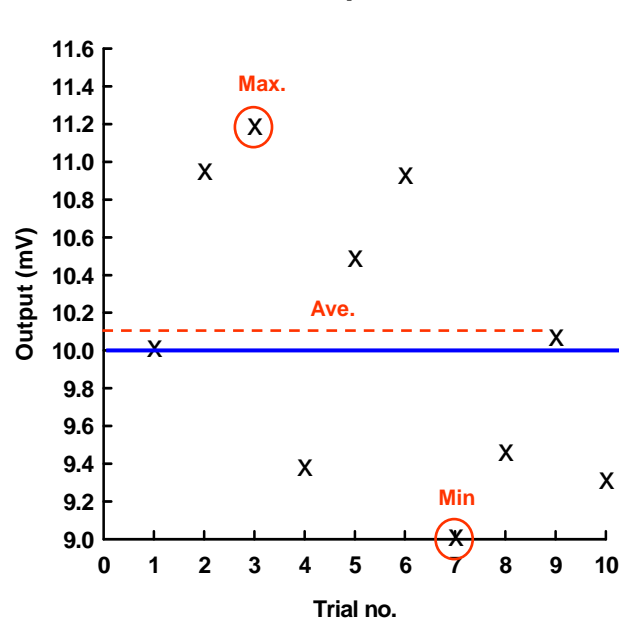

Load cell B

• Not accurate but repeatable

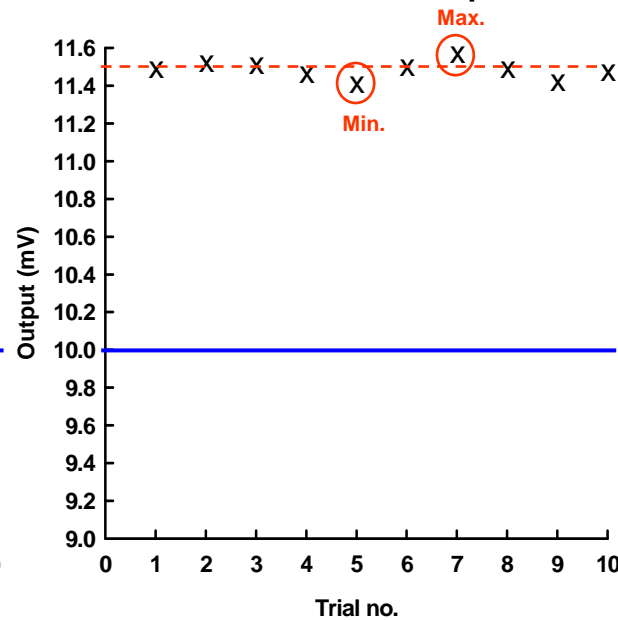

Load cell C

• Accurate and repeatable

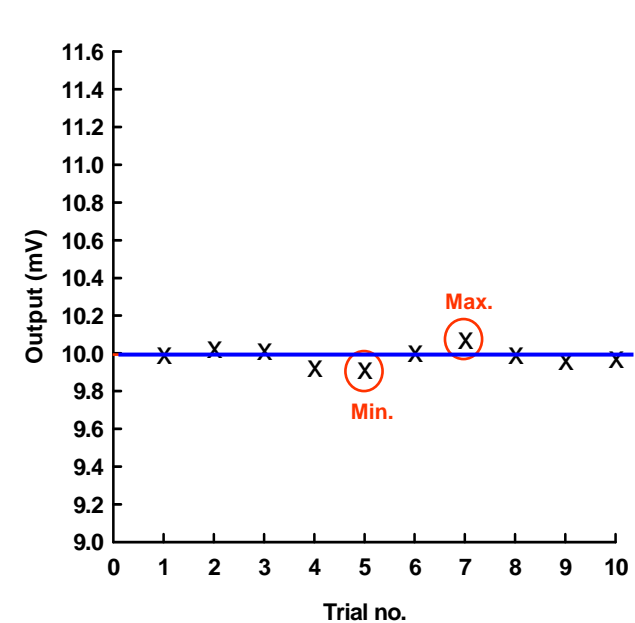

A transducer or sensor that is repeatable but not overly accurate may still be quite usable in a measurement or control application. As long as the transducer or sensor is repeatable, you will get consistent results. We may correct this inaccuracy by the recalibration this transducer or sensor.

Static Characteristics

Resolution: the smallest increment in the value of the measurand that results in a detectable increment in the output. It is expressed in the percentage of the measurand range

$$\text{Resolution (\%)} = \frac{\Delta x}{x_{\max} - x_{\min}} \times 100$$

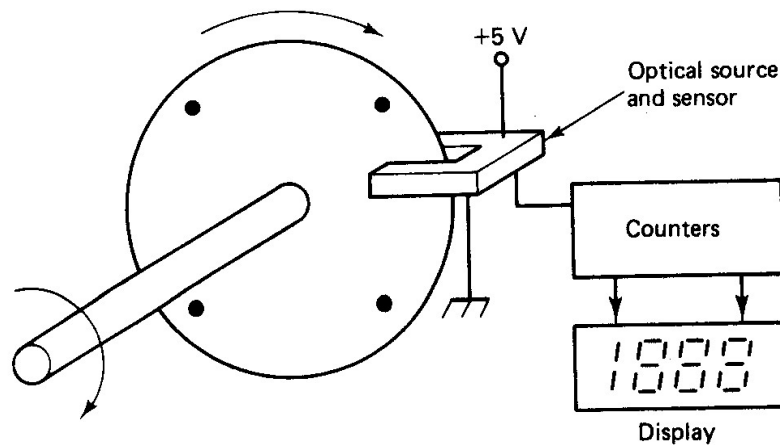

A simple optical encoder

Each time the shaft rotates $\frac{1}{4}$ of a revolution, a pulse will be generated. So, this encoder has a 90° resolution.

Static Characteristics

Hysteresis: Difference in the output of a sensor or instrument for a given input value x , when x is increased and decreased or vice versa. (expressed in % of FSO) (indication of reproducibility)

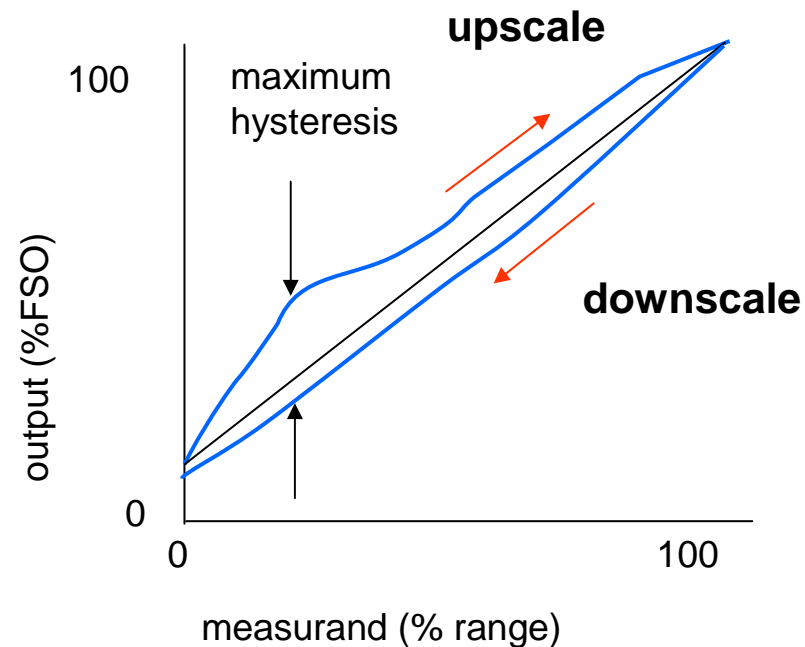

Static Characteristics

Linearity: (also called Nonlinearity) A measure of deviation from linear of a sensor or instrument, which is usually described in terms of the percentage of FSO.

- (1) best-fit straight line
- (2) terminal-based straight line
- (3) independent straight line

A predicted output based on linear relation:

$$y_L(x) = a_0 + a_1x$$

Linearity error:

$$e_L(x) = y(x) - y_L(x)$$

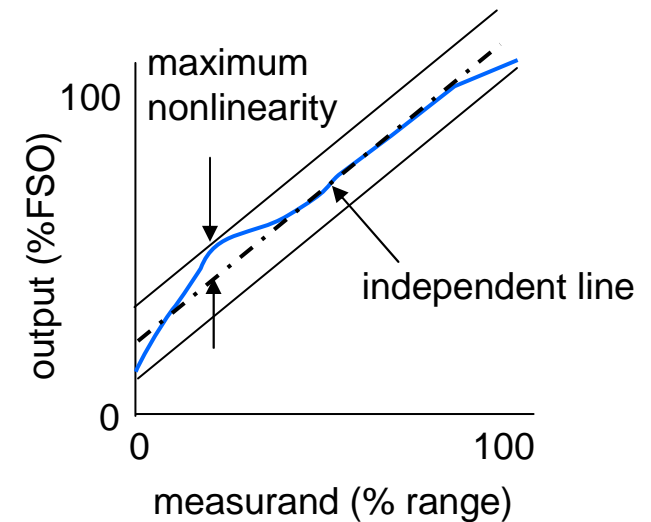
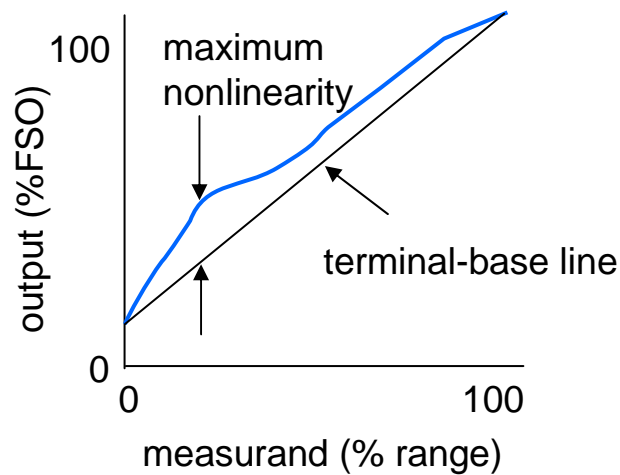
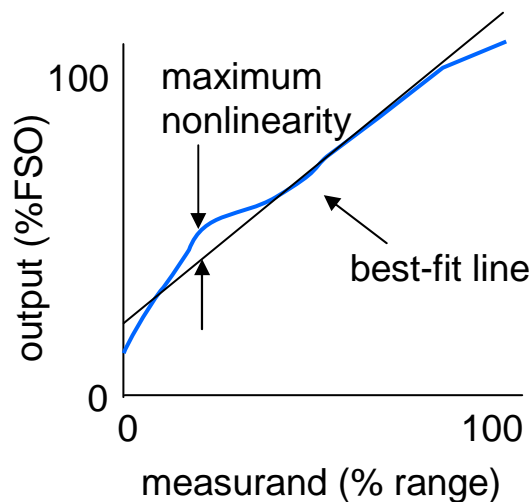

Static Characteristics

Operating conditions: Ambient conditions may have profound effects on the sensor or instrument operation. These include temperature, acceleration, vibration, shock, pressure, moisture, corrosive materials, and electromagnetic field.

Temperature zero drift: the change in the output level of a sensor or instrument due to temperature variation when the input is set to zero.

Temperature sensitivity drift: the change in the output level of a sensor or instrument due to temperature when the input is set to the specific range.

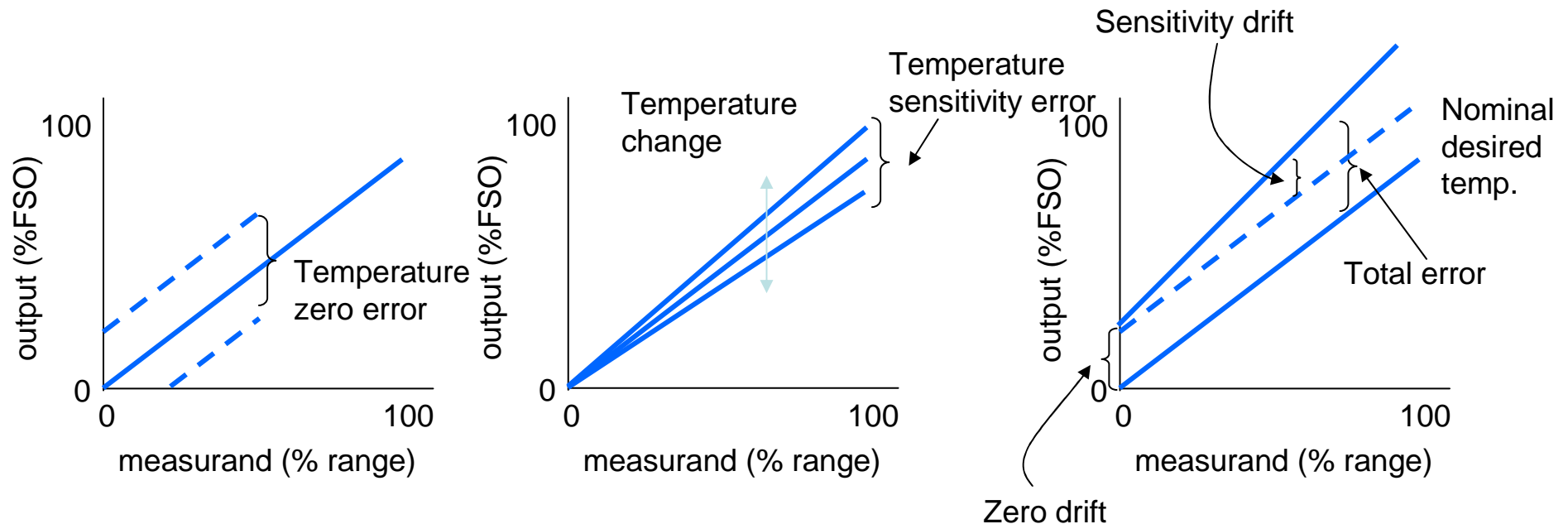

Static Characteristics

Overall Performance: An estimate of the overall sensor error is made based on all known errors. An estimate is computed from

The worst case approach:

$$e_c = |e_1| + |e_2| + |e_3| + \cdots + |e_n|$$

The root of sum square approach:

$$e_{rss} = \sqrt{e_1^2 + e_2^2 + e_3^2 + \cdots + e_n^2}$$

Specifications: Typical Pressure Sensor

<i>Operation</i>	
Input range	0-1000 cm H ₂ O
Excitation	±15 V dc
Output range	0-5 V
Temperature range	0-50°C nominal at 25°C
<i>Performance</i>	
Linearity error e_L	±0.5%FSO
Hysteresis error e_h	Less than ±0.15%FSO
Sensitivity error e_s	±0.25%of reading
Thermal sensitivity error e_{ST}	0.02%/°C of reading from 25°C
Thermal zero drift e_{ZT}	0.02%/°C FSO from 25°C

The sensor is used to measure a pressure of 500 cm H₂O the ambient temperature is expected to vary between 18°C and 25°C . Estimate the magnitude of each elemental error affecting the measured pressure

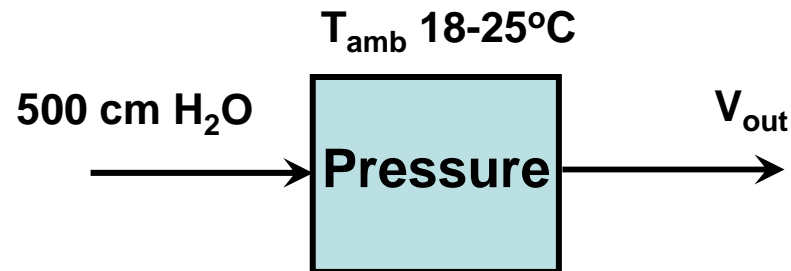

Error budget calculation of a pressure sensor

<i>Performance</i>	<i>Absolute error output</i>	<i>Absolute error transfer to input</i>
Linearity error e_L	± 25 mV	± 5 cm H ₂ O
Hysteresis error e_h	± 7.5 mV	± 1.5 cm H ₂ O
Sensitivity error e_s	± 6.25 mV	± 1.25 cm H ₂ O
Thermal sensitivity error e_{ST}	$- 3.5$ mV	-0.7 cm H ₂ O
Thermal zero drift e_{ZT}	$- 7.0$ mV	-1.4 cm H ₂ O
Worst case error	± 49.25 mV = 0.99 %FSO	± 9.9 cm H ₂ O
Root square error	± 27.95 mV = 0.56 %FSO	± 5.6 cm H ₂ O

Worst case error

$$\begin{aligned} e_c &= |e_L| + |e_h| + |e_s| + |e_{ST}| + |e_{ZT}| \\ &= \pm 25 \pm 7.5 \pm 6.25 \pm 3.5 \pm 7 = \pm 49.25 \text{ mV} \\ &= 0.99 \% \text{FSO} = 1.98 \% \text{reading} \end{aligned}$$

Root of sum square error

$$\begin{aligned} e_{rss} &= \sqrt{e_L^2 + e_h^2 + e_s^2 + e_{ST}^2 + e_{ZT}^2} \\ &= \sqrt{25^2 + 7.5^2 + 6.25^2 + 3.5^2 + 7^2} = \pm 27.95 \text{ mV} \\ &= \pm 0.56 \% \text{FSO} = \pm 1.12 \% \text{reading} \end{aligned}$$

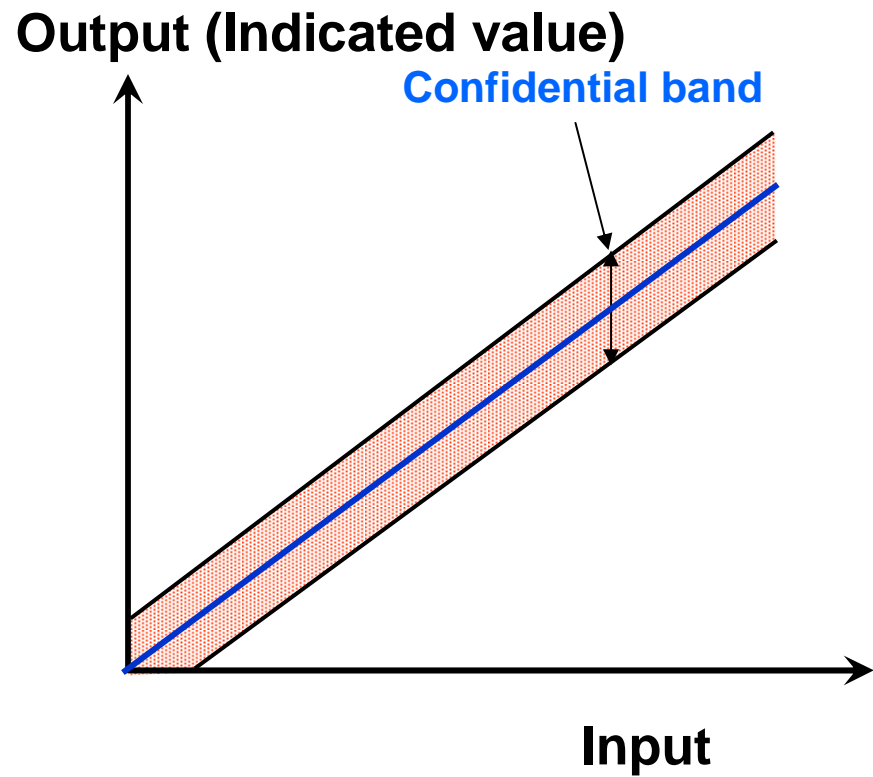

Basic specifications

- Input range
- Output range
- Offset
- Sensitivity

Performance specifications

- Accuracy
- Resolution
- Repeatability
- Hysteresis
- Linearity
- environmental parameter
- etc.

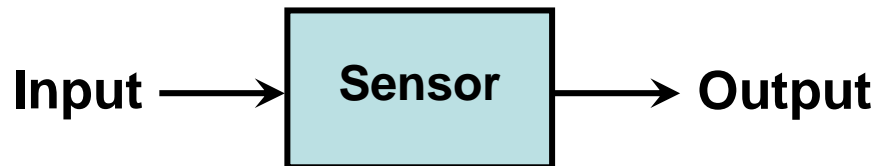

Static Characteristics

Example: A load cell is a sensor used to measure weight. A calibration record table is given below. Determine (a) accuracy, (b) hysteresis and (c) linearity of the sensor. If we assume that the true or expected output has a linear relationship with the input. In addition, the expected output are 0 mV at 0 kg load and 20 mV at 50 kg load.

Load (kg)	Output (mV)	
	Increasing	Decreasing
0	0.08	0.06
5	0.45	0.88
10	1.02	2.04
15	1.71	3.10
20	2.55	4.18
25	3.43	5.13
30	4.48	6.04
35	5.50	7.02
40	6.53	8.06
45	7.64	9.35
50	8.70	10.52
55	9.85	11.80
60	11.01	12.94
65	12.40	13.86
70	13.32	14.82
75	14.35	15.71
80	15.40	16.84
85	16.48	17.92
90	17.66	18.70
95	18.90	19.51
100	19.93	20.02

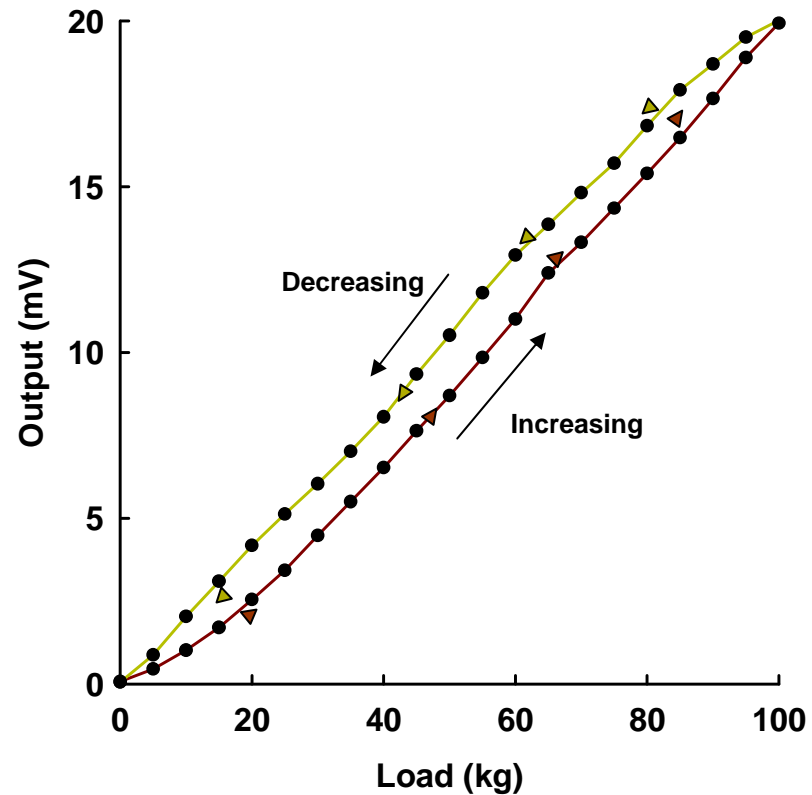

Static Characteristics

(a) Accuracy

Load (kg)	True Output (mV)	Actual Output (mV)	Error (mV)	%FSO	%reading
0	0	0.08	0.08	0.40	a
5	1	0.45	-0.55	-2.75	-55.00
10	2	1.02	-0.98	-4.90	-49.00
15	3	1.71	-1.29	-6.45	-43.00
20	4	2.55	-1.45	-7.25	-36.25
25	5	3.43	-1.57	-7.85	-31.40
30	6	4.48	-1.52	-7.60	-25.33
35	7	5.5	-1.50	-7.50	-21.43
■	■	■	■	■	■
■	■	■	■	■	■
■	■	■	■	■	■
40	8	8.06	0.06	0.30	0.75
35	7	7.02	0.02	0.10	0.29
30	6	6.04	0.04	0.20	0.67
25	5	5.13	0.13	0.65	2.60
20	4	4.18	0.18	0.90	4.50
15	3	3.1	0.10	0.50	3.33
10	2	2.04	0.04	0.20	2.00
5	1	0.88	-0.12	-0.60	-12.00
0	0	0.06	0.06	0.30	a

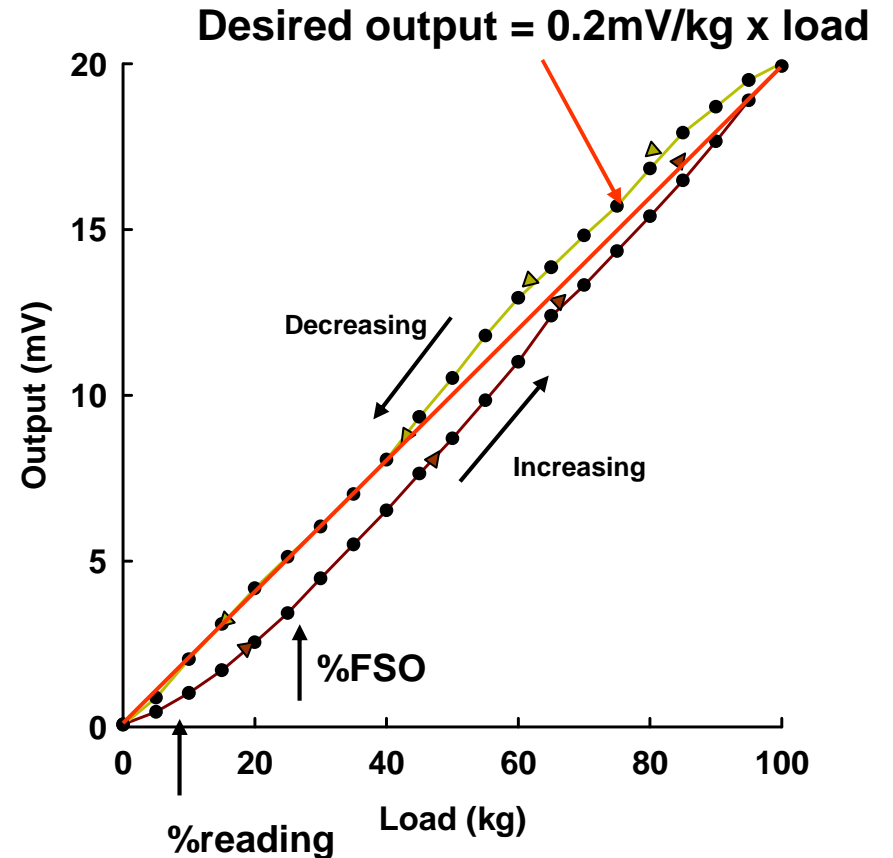

Accuracy: %FSO = -7.85% at 25 kg increasing
%reading = -55% at 5 kg increasing

Static Characteristics

(b) Hysteresis

Load (kg)	Output (mV)		Hysteresis (%FSO)
	Increasing	Decreasing	
0	0.08	0.06	0.10
5	0.45	0.88	2.15
10	1.02	2.04	5.10
15	1.71	3.10	6.95
20	2.55	4.18	8.15
25	3.43	5.13	8.50
30	4.48	6.04	7.80
35	5.50	7.02	7.60
40	6.53	8.06	7.65
45	7.64	9.35	8.55
50	8.70	10.52	9.10
55	9.85	11.80	9.75
60	11.01	12.94	9.65
65	12.40	13.86	7.30
70	13.32	14.82	7.50
75	14.35	15.71	6.80
80	15.40	16.84	7.20
85	16.48	17.92	7.20
90	17.66	18.70	5.20
95	18.90	19.51	3.05
100	19.93	20.02	0.45

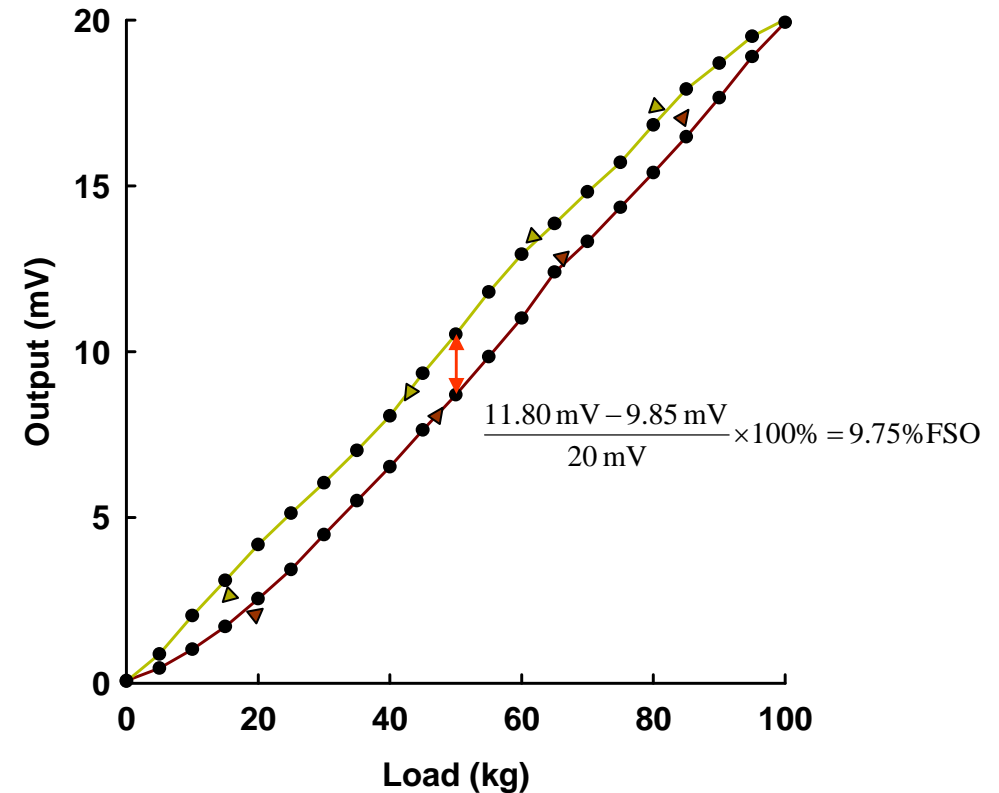

Hysteresis = 9.75 %FSO at 55 kg

Static Characteristics

(c) Linearity: Terminal-based straight line (endpoint straight line)

Load (kg)	Endpoint line (mV)	Actual Output (mV)	Linearity (%FSO)
0	0	0.08	0.40
5	1	0.45	-2.75
10	2	1.02	-4.90
15	3	1.71	-6.45
20	4	2.55	-7.25
25	5	3.43	-7.85
30	6	4.48	-7.60
35	7	5.50	-7.50
■	■	■	■
■	■	■	■
■	■	■	■
40	8	8.06	-0.30
35	7	7.02	-0.10
30	6	6.04	-0.20
25	5	5.13	-0.65
20	4	4.18	-0.90
15	3	3.10	-0.50
10	2	2.04	-0.20
5	1	0.88	0.60
0	0	0.06	-0.30

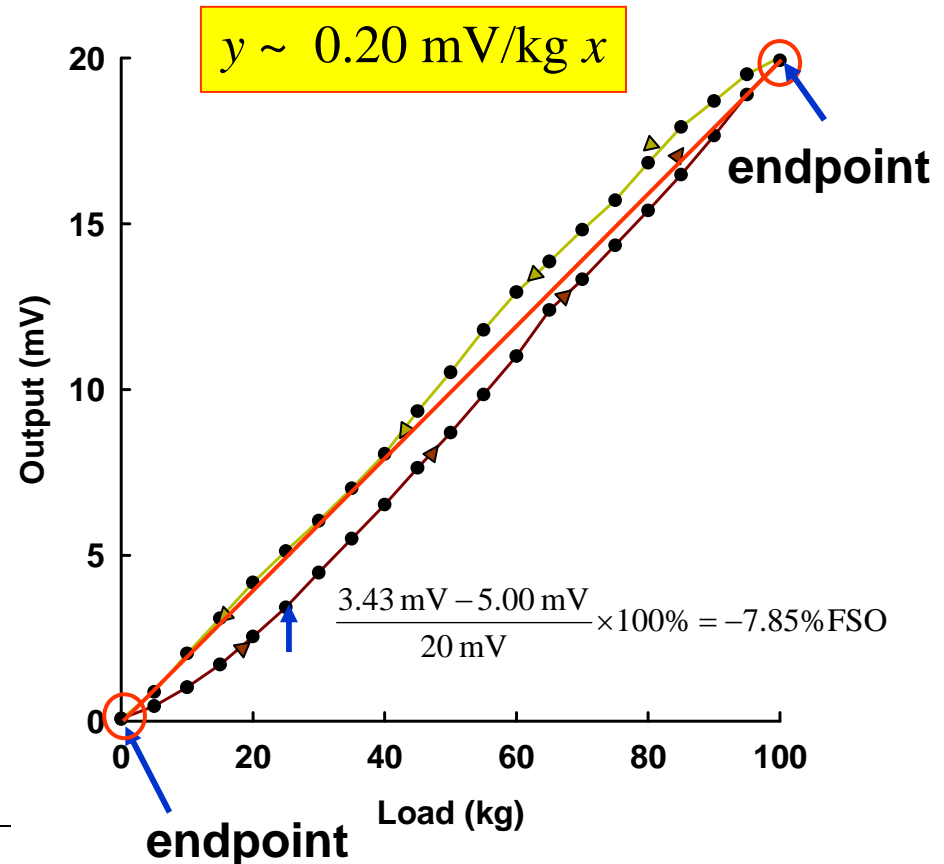

Linearity = -7.85 %FSO (at 25 kg)

Static Characteristics

(c) Linearity: Best-fit straight line

Least square method: minimizes the sum of the square of the vertical deviations of the data points from the fitted line.

Here, we will estimate y by $y = mx + b$

$$m = \frac{N \sum xy - \sum x \sum y}{N \sum x^2 - (\sum x)^2}$$

$$b = \frac{\sum y}{N} - m \frac{\sum x}{N}$$

N = Total number of data points

Static Characteristics

$x = \text{Load (kg)}$

$y = \text{Load cell output (mV)}$

Here No. of Data $N = 42$

x	y	x^2	xy	
0	0.08	0.00	0	
5	0.45	25.00	2.25	
10	1.02	100.00	10.2	
15	1.71	225.00	25.65	
20	2.55	400.00	51	
25	3.43	625.00	85.75	
30	4.48	900.00	134.4	
35	5.50	1225.00	192.5	
40	6.53	1600.00	261.2	
45	7.64	2025.00	343.8	
■	■	■	■	
■	■	■	■	
■	■	■	■	
45	9.35	2025.00	420.75	
40	8.06	1600.00	322.4	
35	7.02	1225.00	245.7	
30	6.04	900.00	181.2	
25	5.13	625.00	128.25	
20	4.18	400.00	83.6	
15	3.10	225.00	46.5	
10	2.04	100.00	20.4	
5	0.88	25.00	4.4	
0	0.06	0.00	0	
Σ	2100	409.89	143500	28499.45

$$m = 0.2079 \text{ mV/kg}$$

$$b = -0.6368 \text{ mV}$$

Obtained eq.

$$y = 0.2079 \text{ mV/kg } x - 0.6368 \text{ mV}$$

Static Characteristics

(c) Linearity: Best-fit straight line

Load (kg)	best-fit line (mV)	Actual Output (mV)	Linearity (%FSO)
0	-0.64	0.08	-3.45
5	0.40	0.45	-0.23
10	1.44	1.02	2.03
15	2.48	1.71	3.71
20	3.52	2.55	4.67
25	4.56	3.43	5.44
30	5.60	4.48	5.39
35	6.64	5.50	5.48
40	7.68	6.53	5.53
45	8.72	7.64	5.19
50	9.76	8.70	5.09
■	■	■	■
■	■	■	■
■	■	■	■
55	10.80	11.80	-4.82
50	9.76	10.52	-3.66
45	8.72	9.35	-3.04
40	7.68	8.06	-1.83
35	6.64	7.02	-1.83
30	5.60	6.04	-2.12
25	4.56	5.13	-2.74
20	3.52	4.18	-3.17
15	2.48	3.10	-2.97
10	1.44	2.04	-2.88
5	0.40	0.88	-2.30
0	-0.64	0.06	-3.35

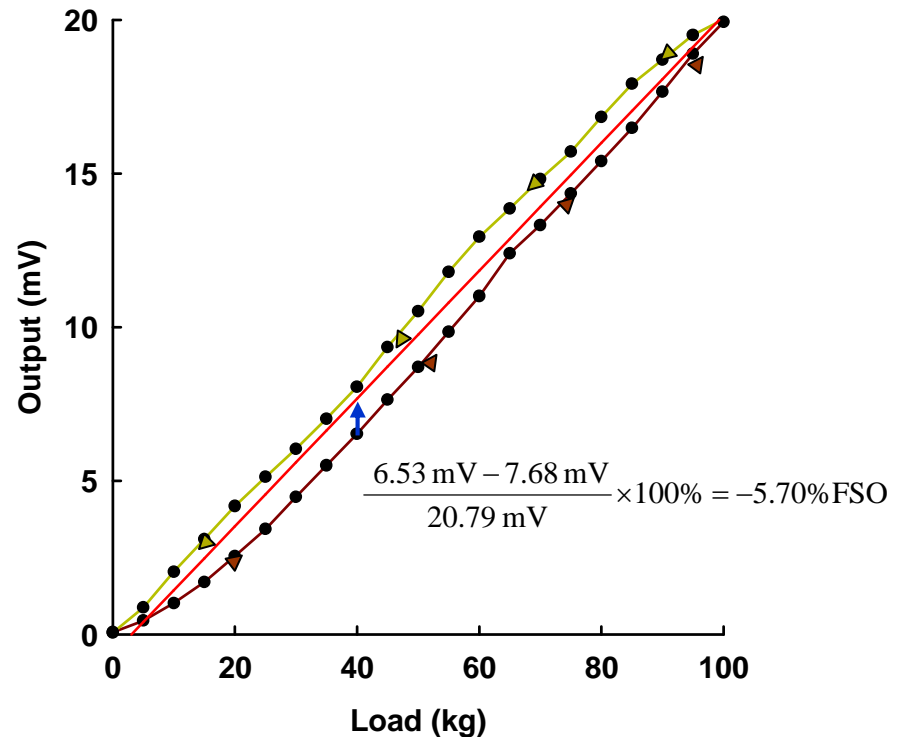

Linearity = -5.70 %FSO (at 40 kg)

Static Characteristics

(c) Linearity: Independent straight line

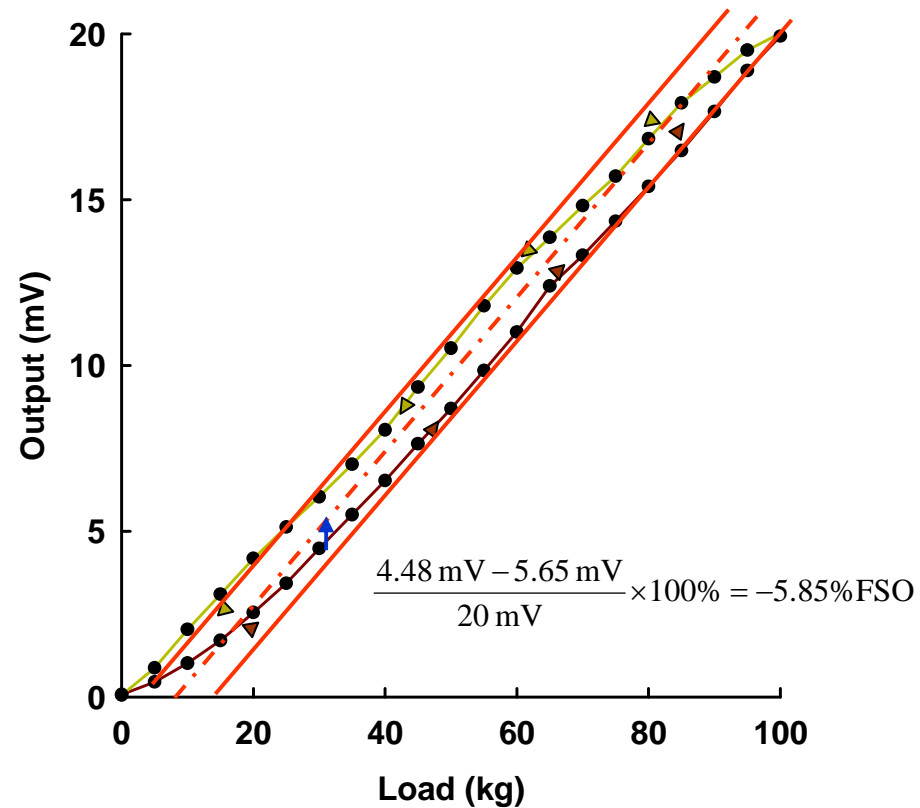

Linearity = -5.85 %FSO (at 30 kg)